

medela 
mother's milk,
everyday amazing™

For hospital
purchasers

**Next-generation
benefits in milk
removal for hospitals**

PersonalFit™ PLUS pump sets for Symphony®

More milk. More comfort. More efficiency.



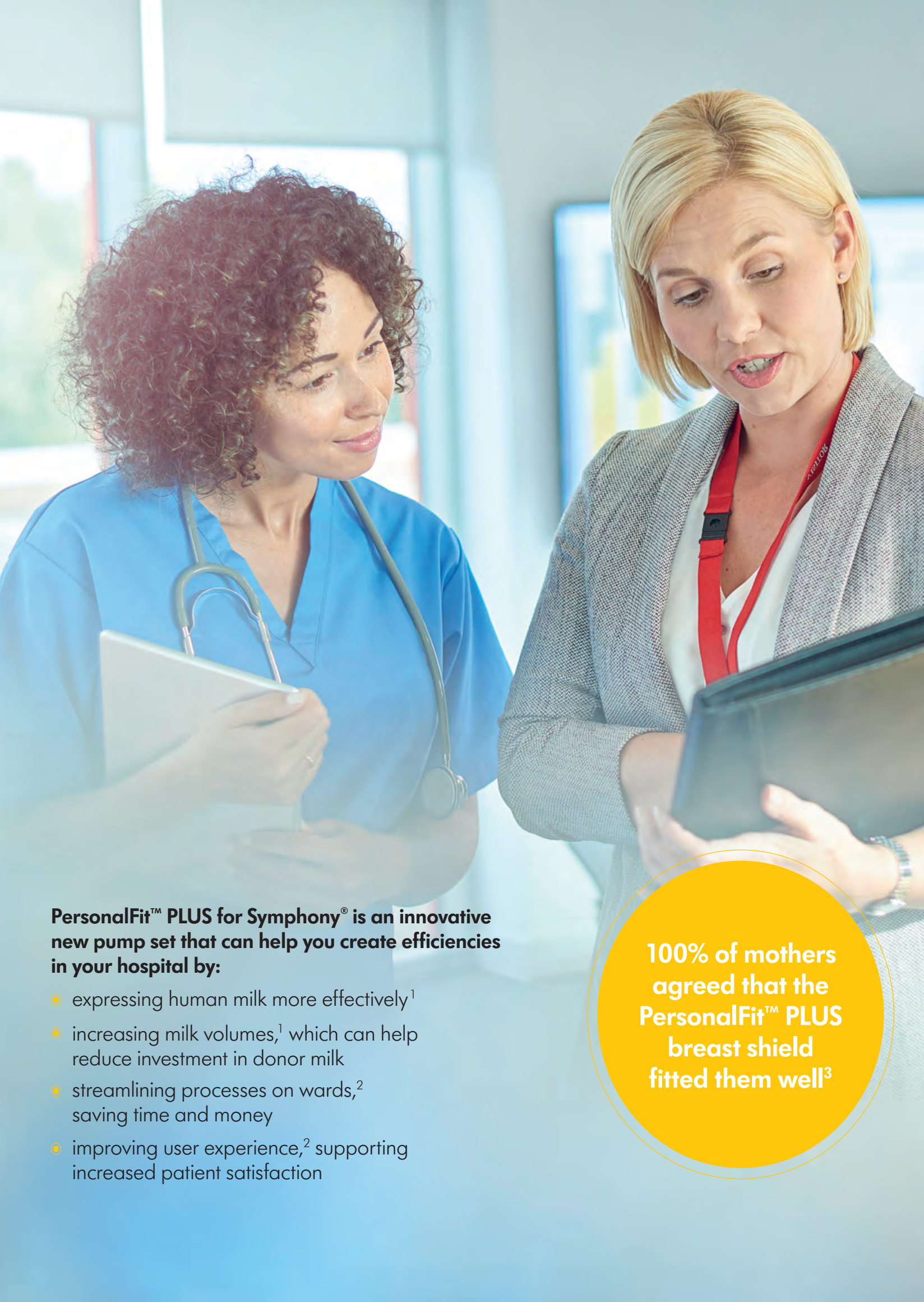

PersonalFit™ PLUS for Symphony® is an innovative new pump set that can help you create efficiencies in your hospital by:

- expressing human milk more effectively¹
- increasing milk volumes,¹ which can help reduce investment in donor milk
- streamlining processes on wards,² saving time and money
- improving user experience,² supporting increased patient satisfaction

100% of mothers agreed that the PersonalFit™ PLUS breast shield fitted them well³

PersonalFit™ PLUS: The new standard in pump set design

Developed by scientists, tested with mothers, proven in hospitals¹⁻³

105° flange angle allows optimal nipple placement, while minimising breast tissue compression.⁴

Oval breast shield can be rotated, making it easier to fit to different breast shapes.

Range of different tunnel sizes helps ensure the optimum breast shield fit.

Integrated overflow protection allows the mother to find a comfortable pumping position for a relaxed pumping experience.

The connector has a hinged section for simple assembly.

PersonalFit™ PLUS pump sets are compatible with Medela human milk collection bottles: simply screw on the required size.



Hospital reusable pump set

Multi-user product that is suitable for reprocessing.

Hospital disposable pump sets

Come in Sterile and Ready-to-Use versions. Both can be used straight from packaging.



PersonalFit™ PLUS works with the Symphony® breast pump. Together, they create a complete system for optimising breast milk expression, making more milk available when it is needed most.

References

1 Prime D. K. et al. Influence of a newly designed breast shield on the dynamics of milk removal: A randomised controlled trial [poster]. 6th Academy of Breastfeeding Medicine Europe Conference, 18-20 May 2018, Rotterdam, Netherlands; 2018. **2** Clinical study, PersonalFit™ PLUS compared to PersonalFit™ in the hospital setting, data on file (NCT02496429). 2015. **3** Clinical study, PersonalFit™ PLUS compared to PersonalFit™ in the home setting, data on file (NCT02492139.) 2016. **4** Schlienger A et al. Optimisation of breastshield shape with the aim of improving breast expression (P-25); Abstracts from the 18th International Society for Research in Human Milk and Lactation Conference. Breastfeed Med. 2016; 11(2):A28-A29.

Discover what PersonalFit™ PLUS can do for your next generation. Go to medela.com/pfp or contact your Medela representative

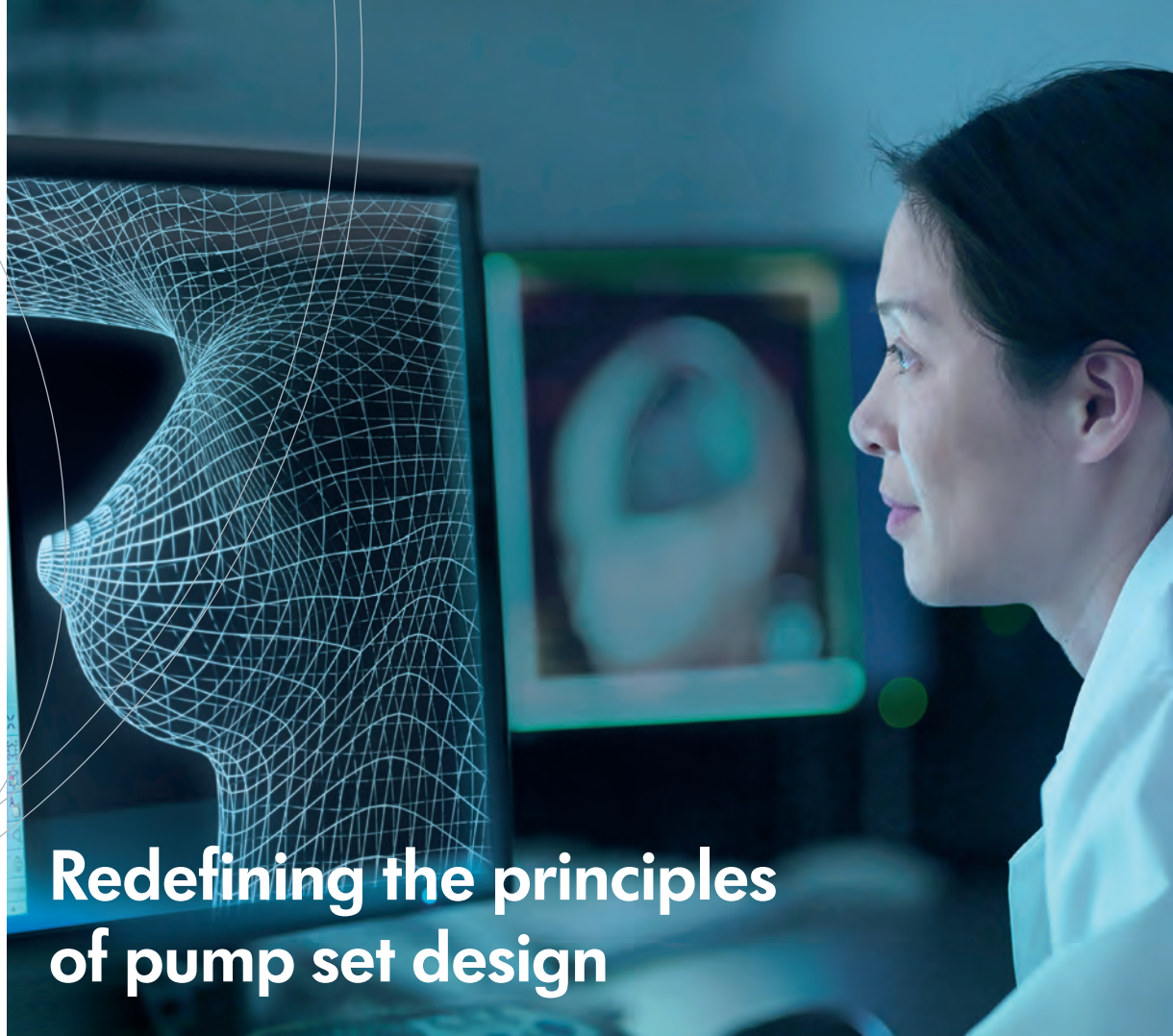

Redefining the principles of pump set design

The PersonalFit™ PLUS pump set for Symphony® is clinically proven to deliver more milk,¹ more comfort,^{1,2} and more efficiency¹ than standard pump set designs. The result is a next-generation pump set that helps more infants receive the life-giving benefits of human milk. To develop it, Medela embarked upon groundbreaking research based on its expertise in the science of expressing breast milk. This demonstrated – for the first time – the crucial role breast shield shape plays in optimising milk expression.

PersonalFit™ PLUS pump sets for Symphony®

More milk. More comfort. More efficiency.





Innovation driven by research

How Medela made the breakthrough

Research has shown that a well-fitting breast shield is essential for comfortable, effective pumping.³ Ideally the nipple should be centred within the tunnel, with space to expand and move freely, which is why Medela breast shields come in a range of tunnel sizes. However, by observing pumping mothers, Medela's researchers noted that even when the tunnel size was correct, there was a mismatch between the breast shape and the shape of the other part of the shield, the flange – which, like most other breast shields, has had a standard 90° angle for the past 50 years.

Unique 3D breast scan database

Medela's researchers used their unique database of 3D scans of different lactating breasts – the world's largest – to simulate and assess the fit of the 90° breast shield.⁴ They discovered that in two-thirds of cases the nipple tip did not reach into the tunnel. In addition, there was point contact at the rim, possibly resulting in localised breast tissue compression.⁴ If this tissue is compressed it potentially reduces milk flow from the ducts – Medela supported pioneering research into breast anatomy that revealed milk ducts were closer to the skin's surface than previously thought.⁵

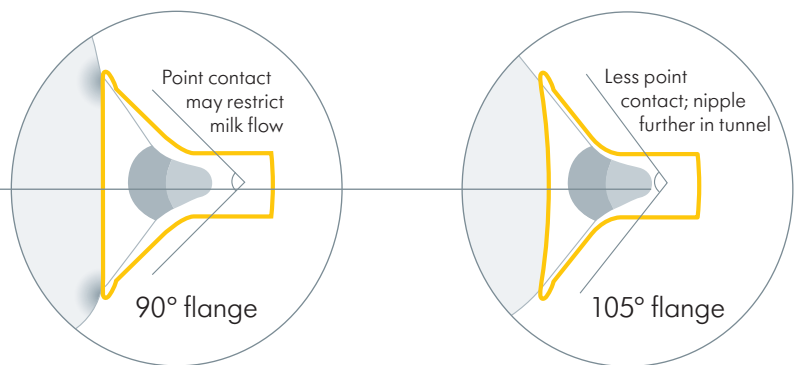

By testing wider-angled flanges, the researchers found 105° better matched the contours of the scanned breasts, regardless of shape or size. In addition, the nipple was placed further into the tunnel and point contact was reduced at the rim – suggesting a more comfortable pumping experience for mothers, and the possibility of improved milk flow.⁴

Why an oval?

Medela product developers also altered the shape of the shield's opening from a circle to an oval that can be rotated 360°. This means the mother can hold it in different positions at the breast – horizontally, vertically or obliquely – whichever feels most comfortable for her. It maintains a good seal and fit in all these positions.

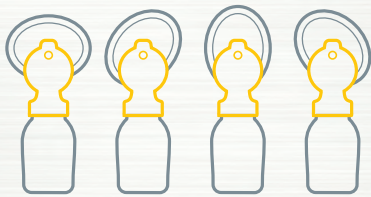

Tested in three extensive clinical studies

Results from more than 1,000 pumping sessions



More milk

After 15 minutes of pumping, 11% more milk was obtained

Forty-nine mothers in established lactation took part in a randomised controlled trial. They performed a total of 196 breast expressions with the standard and new pump sets.

Results: After 15 minutes of pumping, the PersonalFit™ PLUS pump set obtained 11% more milk than the standard design.¹ There was also a 4% improvement in breast drainage¹ – significant, as a key principle of maintaining milk production is to drain the breast well.⁶



More comfort

Mothers described pumping as more gentle and natural

Twenty-two pump-dependant mothers rated their experiences of using PersonalFit™ PLUS at home for seven days, and after seven days of using the standard pump set.

Results: Expressing breast milk with the PersonalFit™ PLUS pump set was described as feeling more gentle and natural.⁷



More efficiency

Significant improvement in usability and handling

Twenty-five healthcare professionals observed mothers using the new pump set in hospital for five days.

Results: They recorded significant improvements in the cleaning and overall usability and handling of PersonalFit™ PLUS.⁷

Designed for busy carers and mothers

As well as redesigning the breast shield, Medela refined the pump set's construction so it now consists of just a few parts, including the shield, connector with lid, overflow protection membrane, and tubing with Symphony® cap. The aim was to streamline the milk removal process to save time and effort, an improvement validated by usability tests in hospitals and homes.

Only Medela

Research is in Medela's DNA. Medela has successfully developed long-standing relationships with leading researchers, generating knowledge that often challenges fundamental principles. This provides a scientific basis for product development and clinical testing.



View the evidence

1 Prime DK et al. 6th ABM Europe Conference, Rotterdam, NL; 2018. 2 Clinical study. (NCT02492139). 2016. 3 Jones E, Hilton S. J Neonatal Nurs. 2009; 15(1):14–17. 4 Muther M et al. Breastfeed Med. 2016; 11(2):A28. 5 Ramsay DT et al. J Anat. 2005; 206(6):525–534. 6 Kent JC et al. J Obstet Gynecol Neonatal Nurs. 2012; 41(1):114–121. 7 Clinical study. (NCT02496429). 2015.

Discover what PersonalFit™ PLUS can do for your next generation. Go to medela.com/pfp or contact your Medela representative



Delivering next-generation standards of comfort for mothers

The PersonalFit™ PLUS pump set for Symphony® has been designed to follow the natural contours of the lactating breast to promote gentle pumping. It has been clinically proven to offer a more comfortable pumping experience, with 100% of mothers positively evaluating its fit in tests.^{1,2}

PersonalFit™ PLUS pump sets for Symphony®

More milk. More comfort. More efficiency.



Tested with mothers in clinical trials



A more natural look

The redesigned oval shape of the PersonalFit™ PLUS breast shield helps put mothers at ease, as Dr Danielle Prime, Medela Medical Research Associate, explains: "Mothers have an emotional reaction to the new pump set. They say it looks more comfortable before they have even pumped with it, and then find their experience matches that expectation."



A more natural fit

Using Medela's unique database of 3D scans of lactating breasts, researchers identified a 105° breast shield flange angle as the optimal anatomical match. This was verified when the new PersonalFit™ PLUS pump set was tested with mothers:

- 100% said it fitted well to the breast²
- 95.5% said it centred well²

And because the new oval breast shield can be rotated 360°, the user can easily change its position to what feels most comfortable for that pumping session.



A more natural feel

Medela aims to make milk expression feel as close to the infant's natural breastfeeding behaviours as possible. The first clinical trials of PersonalFit™ PLUS revealed that pump-dependent mothers found it gentler and easier to use than the standard pump set.²

- 83% said expression felt more natural²
- 95.5% experienced minimal skin rubbing²
- 100% reported no or minimal skin pressure marks²

They also said that PersonalFit™ PLUS gave a much better experience of 'nipple suction' and 'nipple movement', reporting a reduction in pulling sensations.²

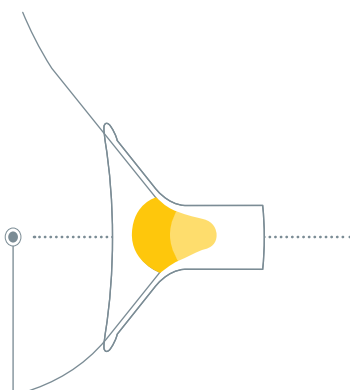

For a good fit, the nipple should be centred within the breast shield tunnel, with space to expand and move freely.

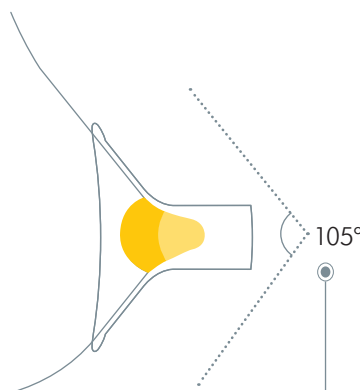

A breast shield flange angle of 105° was also found to reduce potentially uncomfortable point contact at the rim.



The new breast shield can be rotated 360°, so it is possible to hold it in different positions.

100%

said it fitted
the breast well²

83%

said expression
felt more natural²

100%

reported no or minimal
skin pressure marks²



More relaxed pumping experience and more milk

Comfort and relaxation are vital for effective expression because stress and discomfort can inhibit oxytocin, which is essential for milk release.³ 'Pleasant', 'easy' and 'painless' were the most common adjectives used by the mothers who tested the pump set over five days. None of them said that they felt stressed during pumping.²

The PersonalFit™ PLUS pump set also has integrated overflow protection (also referred to as a closed system), so mothers can use it while sitting back in a relaxed position. This is particularly beneficial if they have had a c-section and/or a difficult delivery.

The new pump set removed 11% more milk after 15 minutes compared to the standard design. There was also a 4% improvement in breast drainage¹ – draining the breast well is a key principle of maintaining milk production.⁴

Only Medela

Since 1996, a research partnership between Medela and The University of Western Australia has generated a wealth of new learnings about breastfeeding and the physiology of milk removal. This has helped Medela develop innovations that improve the experience of pumping mothers: including 2-Phase Expression® technology, a pumping pattern that mimics infant sucking behaviour.



11%

more milk after 15 min¹



4%

more breast drainage¹

View the evidence

¹ Prime DK et al. 6th ABM Europe Conference, Rotterdam, NL; 2018. ² Clinical study. [NCT02492139]. 2016. ³ Newton M, Newton N. J Pediatr. 1948; 33(6):698–704. ⁴ Kent JC et al. J Obstet Gynecol Neonatal Nurs. 2012; 41(1):114–121.

Discover what PersonalFit™ PLUS can do for your next generation. Go to medela.com/pfp or contact your Medela representative

medela 

mother's milk,
everyday amazing™

Process optimisation



Making life easier for carers and mothers

The PersonalFit™ PLUS pump set for Symphony® delivers more streamlined, efficient processes on maternity and NICU wards, saving time and money. It also helps make it easier for healthcare professionals to provide mothers with the physical and emotional support they need, while ensuring infants receive all the benefits of an exclusive human milk diet.

PersonalFit™ PLUS pump sets for Symphony®

More milk. More comfort. More efficiency.



150ml
125
100
75
50

More milk when it counts

Not having enough human milk available on maternity and NICU wards can impact infant health. PersonalFit™ PLUS pump sets are clinically proven to remove 11% more milk after 15 minutes, compared to the standard design.¹ And when breastfeeding is impaired, using PersonalFit™ PLUS with the Symphony®'s unique suction patterns can help mothers successfully initiate and build adequate long-term milk production.²

For these reasons, PersonalFit™ PLUS improves the chance of infants receiving an exclusive human milk diet: especially crucial for vulnerable infants for whom every drop counts. For example, feeding human milk reduces the incidence and severity of a variety of infections, including necrotising enterocolitis.³

Having higher volumes of own mother's milk available can also mean:

- major reductions in NICU costs^{4,5}
- earlier transfer of infants from the NICU⁶
- earlier discharge thanks to reduced illness⁶ and enhanced neurodevelopment^{7,8}
- fewer hospital readmissions^{9,10}
- better long-term infant health outcomes¹¹
- reduced reliance on donor milk and formula¹²
- cost savings for hospitals¹³

Increased patient satisfaction

As well as the practical efficiency benefits, PersonalFit™ PLUS is clinically proven to offer mothers a more comfortable pumping experience.¹ And when they use it with the evidence-based Symphony® breast pump,² they can be reassured they are optimally building their supply. This can help them feel more positive about pumping: ultimately supporting improved patient satisfaction scores.

If a mother needs to express at home long-term, using a PersonalFit™ PLUS pump set drives increased levels of satisfaction with rental breast pumps too.

Construction: Simpler and easier to handle

Because PersonalFit™ PLUS parts are larger than those of standard pump sets, they are easier to handle. There are also fewer of them to put together, disassemble and clean, which makes the milk expression process quicker, with less room for user error.



more milk = better health outcomes = cost savings

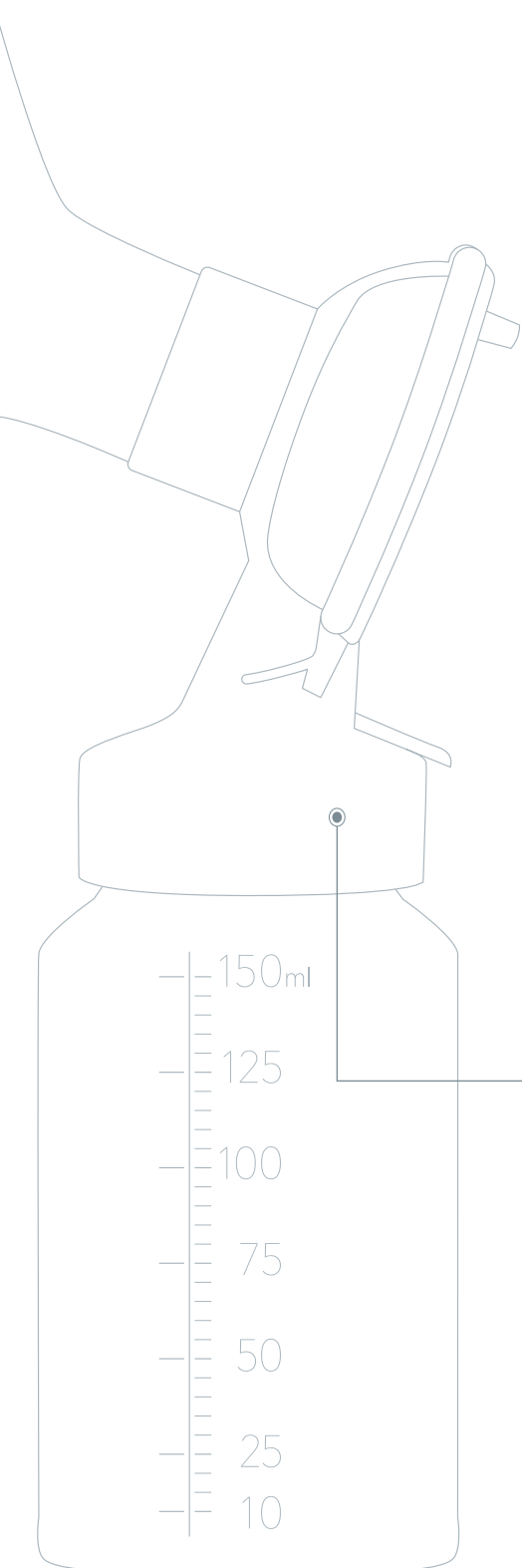

Process: Quicker and more streamlined



PersonalFit™ PLUS range

There are four types of PersonalFit™ PLUS pump sets for Symphony®.

- 1 Sterile disposable pump sets for hospitals that can be used straight from the packaging.
- 2 Ready-to-Use disposable pump sets for hospitals that can also be used straight from the packaging.
- 3 Reusable pump sets for hospitals that are multi-user products, suitable for reprocessing. They can also be sterilised in an autoclave.
- 4 Reusable pump sets that are single-user products for mothers who use a rented Symphony® at home.

An intuitive system

Disposable PersonalFit™ PLUS pump sets offer the easiest process. The user simply washes their hands, takes the parts from the packaging and assembles by:

1. slotting in breast shield
2. affixing tubing
3. screwing on collection bottle

The user then connects the pump set to the Symphony® and starts pumping.

This initial process is the same for all types of PersonalFit™ PLUS pump sets, although the reusable versions must be sanitised before first use and are put together slightly differently: full details are given in the instructions for use.

This straightforward, intuitive system means carers can spend less time giving instructions on pump set use, and more time focusing on mother and infant wellbeing.

Then, after each pumping session:

- Sterile single-use pump sets are disposed of immediately.
- Ready-to-Use pump sets can be used up to eight times within 24 hours before being disposed of. They are simply disassembled, cleaned, dried and reassembled between sessions.
- Reusable pump sets need sanitising once a day, and cleaning after each use as above. Reusable hospital pump sets also need reprocessing between each user. Procedures may differ depending on local regulations and hospital guidelines. Again, full details are in the instructions for use.



Next-generation hygiene



Human milk's remarkable antimicrobial, anti-inflammatory and immunomodulatory properties mean it plays a key role in supporting infants' immune systems.^{14,15} However, its management requires hygienic conditions to maintain quality and safety.

PersonalFit™ PLUS Ready-to-Use disposable pump sets are a safe, cost-effective choice that can be used with term infants, preterm infants, sick infants, and mothers.¹⁶ They are:

- formed at over 150 °C (302 °F) to destroy potential pathogens
- produced and packaged in a cleanroom under laminar flow, which creates an aseptic work area¹⁷
- microbiologically tested¹⁸ before release

PersonalFit™ PLUS Sterile disposable pump sets are available for markets where the use of non-sterile products is not permitted, or when sterile products are requested. They are:

- validated according to applicable standards^{18–21} for sterile medical devices
- treated with ethylene oxide – certified as sterile for entire shelf life
- sealed in individual sterile packaging

Protecting milk from contamination

All PersonalFit™ PLUS pump sets have overflow protection (also referred to as a closed system) for increased levels of hygiene. The membrane that provides the overflow protection fits simply into the pump set connector to help ensure milk cannot enter the tubing, even if the user is sitting back in a relaxed position.



Only Medela

Medela has always shared information and ideas with healthcare professionals, gaining a deep understanding of the challenges they face. Its Breastfeeding and Lactation Symposium is a platform for sharing these experiences and exchanging knowledge – insights Medela uses to develop enhanced pumping solutions and human milk feeding technology.

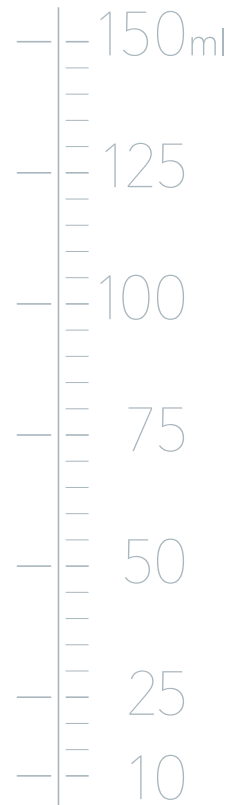

View the evidence

1 Prime DK et al. 6th ABM Europe Conference, Rotterdam, NL; 2018. **2** Meier PP et al. J Perinatol. 2012; 32(2):103–110. **3** Meier PP et al. Clin Perinatol. 2010; 37(1):217–245. **4** Johnson TJ et al. Adv Nutr. 2014; 5(2):207–212. **5** Johnson TJ et al. Neonatology. 2015; 107(4):271–276. **6** Schanler RJ et al. Pediatrics. 2005; 116(2):400–406. **7** Patra K et al. Neonatology. 2017; 112(4):330–336. **8** Lechner BE, Vohr BR. Clin Perinatol. 2017; 44(1):69–83. **9** Vohr BR et al. Pediatrics. 2006; 118(1):e115–e123. **10** Johnson TJ et al. J Perinatol. 2018. **11** Victoria CG et al. The Lancet. 2016; 387(10017):475–490. **12** Meier PP et al. Clin Perinatol. 2017; 44(1):1–22. **13** Mahon J et al. Health Econ Rev. 2016; 6(54). **14** Lobbok MH et al. Nat. Rev Immunol. 2004; 4(7):565–572. **15** Ballard O, Morrow AL. Pediatr Clin North Am. 2013; 60(1):49–74. **16** German Consulting Centre for Hospital Epidemiology and Infection Control (Deutsches Beratungszentrum für Hygiene). Conclusion of the Risk Assessment of the Production Method for Ready-to-Use Products (2014). **17** Laminar flow housing with air quality similar to EN ISO 8 or clean rooms EN ISO certified class 7 or 8 EN ISO 14644-1 Cleanrooms and associated controlled environments – Part 1: Classification of air cleanliness by particle Concentration. **18** EN ISO 11737-1: Sterilization of medical devices – Microbiological methods – Part 1: Determination of a population of microorganisms on products. **19** EN ISO 11607-1: Packaging for terminally sterilized medical devices – Part 1: Requirements for materials, sterile barrier systems and packaging systems. **20** EN ISO 11135-1: Sterilization of health care products – Ethylene oxide – Part 1: Requirements for development, validation and routine control of a sterilization process for medical devices. **21** EN ISO 11607-2: Packaging for terminally sterilized medical devices – Part 2: Validation requirements for forming, sealing and assembly processes.

Discover what PersonalFit™ PLUS can do for your next generation. Go to [medela.com/pfp](https://www.medela.com/pfp) or contact your Medela representative

medela 

mother's milk,
everyday amazing™

Support and training



Supporting healthcare professionals worldwide

As a Medela customer, you benefit from our expertise in the science of expressing breast milk, as well as our portfolio of highest-quality products. Medela's mission is to enhance mother and infant health through the life-giving benefits of human milk. This is why we add value with a unique package of research, training, education and support – sharing knowledge and ultimately improving outcomes for those who matter most: the next generation of infants in your care.

PersonalFit™ PLUS pump sets for Symphony®

More milk. More comfort. More efficiency.



Only Medela



Research

Medela supports work in some of the world's most prestigious universities, research institutes and hospitals, often challenging fundamental principles.

- Ultrasound studies of the lactating breast¹ questioned established models of milk removal and rewrote the textbooks on breast anatomy.
- Research into sucking patterns² changed scientific understanding of infant feeding.
- Comparing double pumping to sequential single pumping revealed it obtained up to 18% more milk volume.³
- Groundbreaking discoveries about the properties of human milk – for example how it contains stem cells⁴ – are continually improving and increasing appreciation of its powerful benefits.

These and many other exciting findings are published in leading journals and presented at global conferences, including Medela's International Breastfeeding and Lactation Symposium.



Innovation

Research-based knowledge is an integral part of Medela's innovation process. Collaborating closely with healthcare professionals helps us design better products, backed by the engineering quality and attention to detail expected from a leading medical equipment manufacturer.

With PersonalFit™ PLUS pump sets for Symphony®, we redefined the principles of pump set design by drawing on our expertise. By creating an exclusive database of 3D breast scans, Medela established a method of investigating differently shaped breast shields that led to applied research and product development. The result is a new pump set, clinically proven to increase the efficiency and comfort of expression.⁵⁻⁷

Training

Medela's highly experienced employees regularly update hospital staff and rental businesses with information about new products and services. Our aim is to support healthcare professionals with appropriate, evidence-based solutions to help mothers at every stage of lactation.

Medela also provides full product support – including face-to-face training – as well as guidance on best practice via how-to-use videos and technical factsheets. The quality and breadth of this service also mean that when mothers are ready to leave the ward, Medela customers can offer them hospital levels of care with confidence.



Education

Medela strives to empower healthcare professionals and mothers to make informed choices by providing educational content, available through a number of channels, both on- and offline.

Key content for healthcare professionals:

- articles and reports on human milk and feeding
- details of clinical research behind Medela products
- evidence-based brochures on core issues
- product factsheets
- posters visualising research projects
- QuickCards: handy product instructions
- education sheets and infographics
- training videos

Key content for mothers:

- the award-nominated *The Amazing Science of Mother's Milk* ebook
- web articles, covering topics ranging from breast changes in pregnancy to weaning, at [medela.com/breastfeeding](https://www.medela.com/breastfeeding)
- education sheets/infographics
- videos and animations on our YouTube channels

These resources form a unique Medela knowledge ecosystem – all free to access and download.

Long-lasting collaborations

Since 1996 Medela's partnership with The University of Western Australia has yielded:

16

full or partial PhD scholarships

84

peer-reviewed journal articles

21

book chapters

20

review articles

196

conference abstracts



Access Medela support

- Medela's website for healthcare professionals: medela.com/breastfeeding-professionals
- Download education materials from: medela.com/breastfeeding-professionals/education/education-materials
- International Breastfeeding and Lactation Symposium: medela.com/breastfeeding-professionals/news-events
- To arrange a training session, contact your local Medela representative.

Highest clinical standards

All Medela clinical trials adhere to the independent standard for Good Clinical Practice (ISO 14155) set by the International Organisation for Standardization (ISO). They are certified by all national ethical and medical authorities in countries where they are conducted.



View the evidence

1 Ramsay DT et al. J Anat. 2005; 206(6):525–534. 2 Geddes DT et al. Early Hum Dev. 2008; 84:471–477. 3 Prime DK et al. Breastfeed Med. 2012; 7(2):100–106. 4 Hassiotou F et al. Stem Cells. 2012; 30(10):2164–2174. 5 Clinical study. (NCT02496429). 2015. 6 Clinical study. (NCT02492139). 2016. 7 Prime DK et al. 6th ABM Europe Conference, Rotterdam, NL; 2018.

Discover what PersonalFit™ PLUS can do for your next generation. Go to medela.com/pfp or contact your Medela representative



Investing in human milk for the next generation

The health and developmental benefits of an exclusive own mother's milk diet make it an invaluable area of investment in infant health. By optimising the milk expression process when breastfeeding is impaired or not possible, the PersonalFit™ PLUS pump set for Symphony® plays an important part in ensuring infants can still receive the benefits of this diet.

PersonalFit™ PLUS pump sets for Symphony®

More milk. More comfort. More efficiency.



Why mother's milk is medicine for preterm infants

Mothers of preterm infants are among the most likely to need help initiating milk supply, while their infants have the most to gain from a human milk diet. Feeding preterm infants with their own mothers' milk is particularly important, as it has more components specific for enhanced immunity and protection than term milk.¹

Own mother's milk (OMM) also helps protect against a range of conditions associated with prematurity, including:

- necrotising enterocolitis (NEC)²
- sepsis³
- retinopathy of prematurity⁴
- bronchopulmonary dysplasia⁵



An OMM diet is crucial for an infant's neurodevelopment. Infants born at 32 weeks still have to develop at least a further 35% of brain volume to reach the capacity of a term infant.⁶ This means they need to catch up rapidly in the postnatal period.



As well as the protective benefits of an OMM diet, preterm mother's milk contains 20% more medium chain fatty acids than term milk: these fatty acids aid brain growth.⁷



Research also shows that, by the time they are 18 months old, very low birth weight (VLBW) infants who received more than 110 ml (3.7 fl oz) per kg (2.2 lb) per day of mother's milk in intensive care have as much as a five-IQ-point advantage over those who were not.⁸



Preterm infants fed human milk are:

- on average discharged two weeks earlier than those fed formula⁹
- 6.8 times less likely to return to hospital in the first year⁸

There is also evidence that breastfeeding and feeding infants breast milk reduce the risk of sudden infant death syndrome (SIDS) and leukaemia, as well as other infections including otitis media.¹⁰

Advantages that last a lifetime

Immediate returns

Infants can start benefiting from an exclusive human milk diet from the beginning – as well as providing optimal nutrition for growth, colostrum is rich in factors that promote intestinal development and reduce infection risk.^{11,12}

The first few hours, days and weeks after birth are a golden opportunity to initiate and build milk production. If this does not happen because breastfeeding is impaired, it is likely to be difficult for the mother to compensate for the resulting shortfall in milk volume.

This is where PersonalFit™ PLUS can help. Used together with the Symphony® breast pump it creates a milk removal system that supports mothers of preterm and term infants to initiate, build and maintain adequate milk production over time. The PersonalFit™ PLUS pump set further enhances Symphony®'s performance by improving the comfort and efficiency of each pumping session, helping mothers express higher milk volumes for infants.^{13,14}

Every drop counts

The more own mother's milk (OMM) an infant receives each day, the lower the risk of disease.

Each additional 10 ml (0.3 fl oz) per kg (2.2 lb) per day reduces the risk of sepsis by up to 19%.³

And each additional 10 ml (0.3 fl oz) of human milk per kg (2.2 lb) per day that an infant receives in the NICU is associated with a 0.35 increase in cognitive index score at 20 months.¹⁹

A long-term investment

The benefits of an exclusive human milk diet last much longer than the infant's hospital or NICU stay, which is why it is important to ensure mothers are building an adequate supply for life at home with their babies.

Human milk feeding reduces the risk of disease over a lifetime. Infants who are breastfed are 13% less likely to become overweight or obese as children or teenagers.¹⁵ This in turn lowers the risk of associated conditions, including type 2 diabetes, coronary heart disease, and a number of cancers.¹⁵⁻¹⁷

Producing breast milk has positive health implications for mothers, too: for every 12 months a woman produces milk, her risk of breast cancer decreases by 4.3%, and this effect is cumulative.¹⁸

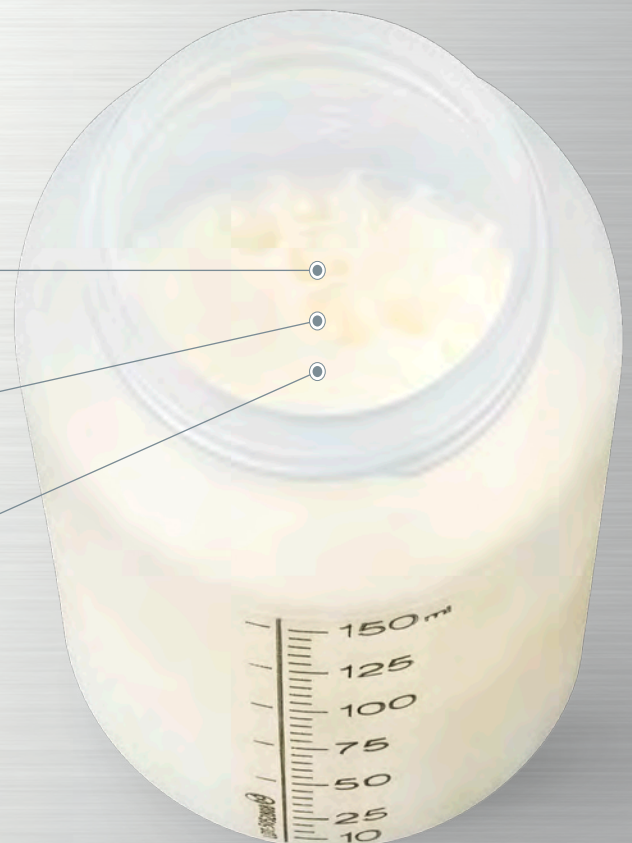

An investment for hospitals

Because it significantly improves both short- and long-term health outcomes, human milk has a high economic value. The fact that it reduces the incidence and/or severity of prematurity-related illnesses means it indirectly reduces associated hospital costs. Taking the examples of necrotising enterocolitis (NEC) and sepsis:

- Preterm infants fed human milk are up to 10 times less likely to contract NEC.²⁰
- USD 43,818 = average costs per case of NEC.²¹
- Each additional 10 ml (0.3 fl oz) per kg (2.2 lb) per day of mother's milk reduces a preterm infant's risk of sepsis by up to 19%.³
- USD 10,055 = average costs per case of sepsis.³

Increased milk volumes with PersonalFit™ PLUS, together with Medela's Initiation technology, can also help to reduce hospitals' reliance on donor milk and formula. As well as having a positive impact on infant health, this can cut costs:

- Own mother's milk costs 60% less than formula and 92% less than donor human milk (when mothers provide 300 to 399 ml, or 10 to 13.5 fl oz, a day).²²
- On a wider scale, if hospitals increased the average daily dose of human milk to more than 50 ml (1.7 fl oz) per kg (2.2 lb) per day in the first 28 days of life, they could save USD 31,154 per infant, or a total of USD 1.8 million.³

While everyone benefits from more human milk being available, it is healthcare professionals who have the opportunity to really make a difference to infants by supporting mothers to provide an exclusive human milk diet. PersonalFit™ PLUS helps make this not only possible, but easier and more efficient.

An investment for every generation

If the next generation of infants benefit from a human milk diet, society benefits too, thanks to increased life expectancy, improved quality of life,¹⁰ and the economic advantages of lower healthcare costs.²³

- On average, in the UK every preterm infant who receives human milk instead of formula contributes lifetime healthcare savings of approximately GBP 904.¹⁰
- GBP 46.7 million: the estimated total lifetime cost saving to the UK's National Health Service if 100% of premature infants were fed mother's milk in the NICU.¹⁰
- There would also be 238 fewer deaths due to neonatal infections and SIDS: this is associated with an economic impact of GBP 153.4 million in lifetime productivity.¹⁰

Only Medela

Medela offers a portfolio of comprehensive, evidence-based feeding development solutions for neonatal intensive care. The aim is to provide milk to hospitalised infants in ways that are as close to breastfeeding as possible, in a manner that supports each individual's feeding ability and maturation.

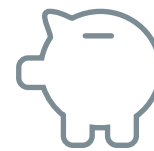

Own mother's milk costs:
(when expressing 300–399 ml per day)²²

60%
less than formula

92%
less than donor human milk

View the evidence

1 Meier P et al. *J Pediatr.* 2017; 180:15–21. 2 Sisk PM et al. *J Perinatol.* 2007; 27(7):428–433. 3 Patel AL et al. *J Perinatol.* 2013; 33(7):514–519. 4 Hylander MA et al. *J Perinatol.* 2001; 21:356–362. 5 Patel AL et al. *Arch Dis Child Fetal Neonatal Ed.* 2017; 102(3):F256–F261. 6 Kinney HC. *Semin Perinatol.* 2006; 30(2):81–88. 7 Fleith M, Clandinin MT. *Crit Rev Food Sci Nutr.* 2005; 45(3):205–229. 8 Vohr BR et al. *Pediatrics.* 2006; 118(1):e115–e123. 9 Schanler RJ et al. *Pediatrics.* 2005; 116(2):400–406. 10 Mahon J et al. *Health Econ Rev.* 2016; 6(1):54. 11 Meier PP et al. *Clin Perinatol.* 2010; 37(1):217–245. 12 Ballard O, Morrow AL. *Pediatr Clin North Am.* 2013; 60(1):49–74. 13 Prime DK et al. 6th ABM Europe Conference, Rotterdam, NL; 2018. 14 Clinical study. (NCT02492139). 2016. 15 Horta BL et al. *Acta Paediatr.* 2015; 104(467):30–37. 16 Bener A et al. *Eur. J. Cancer.* 2001; 37(2):234–238. 17 Amitay EL, Keinan-Boker L. *JAMA Pediatr.* 2015; 169(6):e151025. 18 Collaborative Group on Hormonal Factors in Breast Cancer. *Lancet.* 2002; 360(9328):187–195. 19 Patra K et al. *Neonatology.* 2017; 112(4):330–336. 20 Lucas A et al. *BMJ.* 1990; 300(6728):837–840. 21 Johnson TJ et al. *Neonatology.* 2015; 107(4):271–276. 22 Jegier BJ et al. *J Hum Lact.* 2013; 29(3):390–399. 23 Rollins NC et al. *The Lancet.* 2016; 387:491–504.

Discover what PersonalFit™ PLUS can do for your next generation. Go to medela.com/pfp or contact your Medela representative



Ensuring continuity of care for mothers and infants

Medela aims to support mothers with the right technology at the right time so they can feed their babies breast milk for as long as they choose. By renting a Symphony® and buying PersonalFit™ PLUS for home use, mothers can continue benefiting from the same comfortable¹ and efficient¹ system they started pumping with in hospital. This can reassure them that they are still receiving high standards of care, helping them feel more confident about expressing longer-term.

PersonalFit™ PLUS pump sets for Symphony®

More milk. More comfort. More efficiency.



A pumping solution for each key stage

Supporting mothers and infants in hospital

The Symphony® hospital-grade breast pump has a unique INITIATE program designed to mimic the sucking and pausing patterns of a term infant in the first few days of lactation. This can be used by pump-dependent mothers to stimulate and initiate their milk production.

Mothers can then switch to the Symphony® MAINTAIN program. This uses Medela 2-Phase Expression® technology, a pumping pattern based on the way term infants suck at the breast during established lactation. It is designed to optimise milk output once the mother's milk has come in (around two to four days after birth). These research-based programs have been shown to build and maintain an adequate milk supply for the future.¹

Using the Symphony® breast pump with the PersonalFit™ PLUS pump set instead of the standard design obtains 11% more milk over a 15-minute pumping session, and is 4% more effective at draining the breast.² Overall, this means making higher volumes of own mother's milk available in hospital, which in turn can

support earlier transfer of infants from the NICU and earlier discharges,³ thanks to reduced illness⁴ and enhanced neurodevelopment.⁵

For mothers who have had a c-section or are recovering from a difficult delivery, PersonalFit™ PLUS is particularly beneficial, thanks to its overflow protection feature that allows them to pump in a more relaxed position. PersonalFit™ PLUS is also clinically proven to offer a more comfortable pumping experience, with 100% of mothers positively evaluating the breast shield fit.⁶

by recommending they use a Symphony® from a pump rental station or pharmacy, together with a PersonalFit™ PLUS pump set. This way mothers can continue to initiate, and then build, milk supply at home over the first month just as effectively as they would have done in hospital.

Preparing for life at home

Generally, the average amount of time a mother stays in hospital after giving birth is becoming shorter. In some cases, they are discharged before their milk has come in. In others, the infant may have to remain on the ward while the mother divides her time between hospital and home.

It is important that in these situations mothers experience the same high standards of pumping care wherever they are expressing. Healthcare professionals can support mothers

Ensuring a correct breast shield fit

Because PersonalFit™ PLUS breast shields come in a range of tunnel sizes to help ensure a good fit, mothers will need to measure and note their nipple size ready for when they or a family member collects their rental breast pump.

Medela has a simple breast shield fitting guide that clearly explains how to do this, and the basic principles are outlined in the graphic, right.

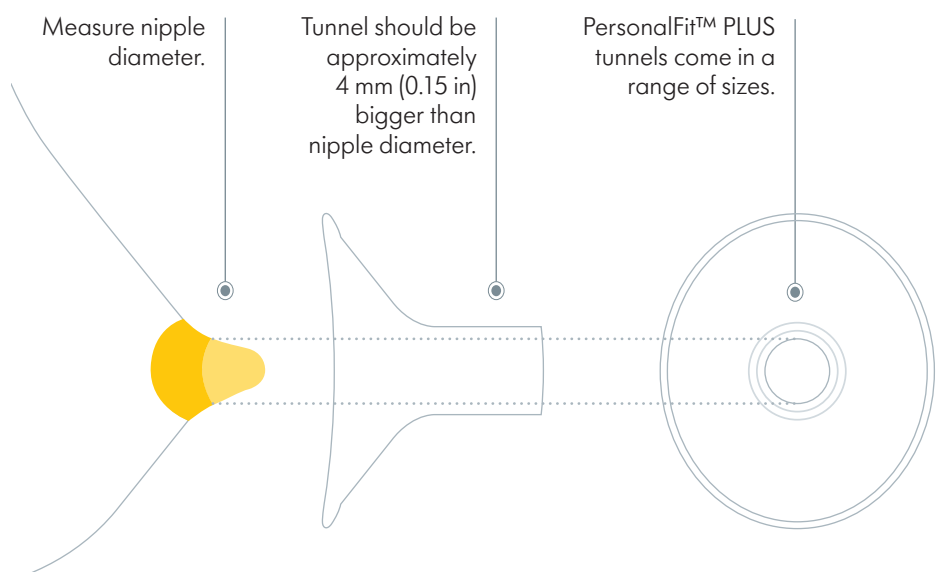

Opportunities for rental stations

Helping mothers achieve their pumping and breastfeeding goals is a powerful tool for creating strong customer loyalty and retention. It also creates the chance to support mothers with more products as their families reach new stages in life.

From additional bottles for storing breast milk, to breast care products, nappies, cleaning supplies and more, cross-selling is a huge opportunity. And because it is often a relative or close friend who visits the rental station on the mother's behalf, particularly in the early days after the birth, this drives customer traffic even further.

A positive customer experience is key to this success, and the levels of care and ease of use Symphony® and PersonalFit™ PLUS offer help to ensure mothers' rental experiences are as satisfying as possible.



Mirroring milk production

After the infant's birth, a mother's milk production follows three stages: Initiate, Build and Maintain. The Symphony® has unique suction patterns that mimic infant feeding behaviour during each stage.¹

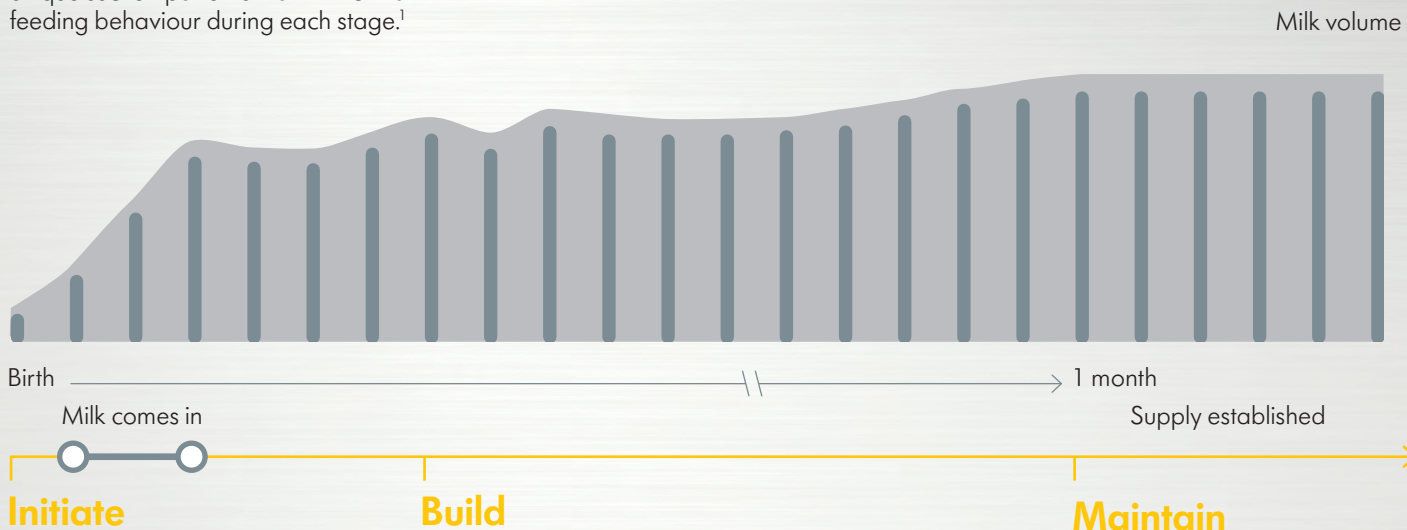

Supporting mothers longer-term

Once supply is established, mothers who are pump-dependent can continue using the Symphony® breast pump with PersonalFit™ PLUS to express frequently. Doing this will obtain breast milk and help maintain supply. When pumping exclusively, the levels of comfort PersonalFit™ PLUS provides remain an important benefit. In addition, because PersonalFit™ PLUS pump sets are easier to use, handle and clean than standard designs,^{6,7} home users require less initial instruction and ongoing support.

Non-pump-dependent mothers who established an adequate milk supply over the first month – whether through breastfeeding, pumping or a combination of the two – may still need to pump to maintain milk supply during any separations from their infant. There are also those who want to pump occasionally to express milk for another caregiver to feed to their baby.

Choosing which breast pump to use at home depends on how many breastfeeds are being replaced by expressing: for example, if mothers are only expressing occasionally a personal-use pump may be an option.⁸ Medela personal-use breast pumps with Flex™ technology offer breast shields with the same proven advantages as PersonalFit™ PLUS.

Medela offers hospital levels of care to pumping mothers – whether they are expressing every other hour, every day, or every now and then.

Only Medela

By using a unique milk flow rate measurement device to gauge milk ejection, Medela researchers found that double pumping obtains 18% more milk on average, compared to single pumping each breast in turn.⁹ The milk expressed was found to have a higher energy content, too.⁹ This is why Medela recommends using a double PersonalFit™ PLUS pump set with the Symphony®.



View the evidence

1 Meier PP et al. J Perinatol. 2012; 32(2):103–110. 2 Prime DK et al. 6th ABM Europe Conference, Rotterdam, NL; 2018. 3 Schanler RJ et al. Pediatrics. 2005; 116(2):400–406. 4 Meier PP et al. Clin Perinatol. 2010; 37(1):217–245. 5 Vohr BR et al. Pediatrics. 2006; 118(1):e115–e123. 6 Clinical study. (NCT02492139). 2016. 7 Clinical study. (NCT02496429). 2015. 8 Meier PP et al. J Perinatol. 2016; 36(7):493–499. 9 Prime DK et al. Breastfeed Med. 2012; 7(6):442–447.

Discover what PersonalFit™ PLUS can do for your next generation. Go to medela.com/pfp or contact your Medela representative

medela 

mother's milk,
everyday amazing™

The Symphony® system



Symphony® and PersonalFit™ PLUS: More milk when it is needed most

The Symphony® is a trusted choice in thousands of hospitals worldwide, thanks to its proven quality and reliability. By mimicking nature, its unique suction patterns support mothers to initiate, build and maintain adequate milk production over time.¹⁻³ The PersonalFit™ PLUS pump set further enhances Symphony®'s performance by improving the comfort and efficiency of each pumping session, helping mothers express more milk in the same time⁴ and delivering next-generation ease of use and simple cleaning.⁵ Together, Symphony® and PersonalFit™ PLUS optimise expression throughout the infant's hospital stay and beyond.

PersonalFit™ PLUS pump sets for Symphony®

More milk. More comfort. More efficiency.



Supporting the milk production process

The milk production process can be described as a continuum of four stages:

1 Develop

The development of breast tissue in preparation for breastfeeding, which occurs primarily during pregnancy when milk-producing cells begin to form.⁶

2 Initiate

After birth, when the nipple is stimulated by the infant sucking, the cells that developed in pregnancy are gradually 'switched on'. This, along with hormonal changes in the mother, leads to secretory activation (milk coming in) two to four days later.⁶

3 Build

Post-secretory activation, milk production starts to increase. Frequent breastfeeding over the first month builds milk supply to meet the infant's ongoing long-term requirements.⁷

4 Maintain

By the end of the first month a full milk supply is usually established, with term infants removing the same volume over 24 hours as they will do at six months.^{8,9}

These stages are interrelated, so it is important to get things right from the start. The Initiate stage between birth and secretory activation is critical for future milk production. When breastfeeding is impaired, stimulating the breast by starting pumping within the first hour after birth, rather than in the first six, can lead to significantly increased milk production later.¹⁰ During the Build and Maintain stages, if the infant is not able to breastfeed, or cannot remove milk effectively, pumping replaces or supplements breastfeeds.

The Symphony® offers a highly effective pumping method, thanks to its two research-based programs: Medela developed its unique INITIATE program to support pump-dependent mothers to stimulate their milk production in a similar way to a term infant. MAINTAIN, meanwhile, is designed to optimise milk output after secretory activation, in order to build and maintain lactation.¹⁻³

Around 40% of mothers are at risk of delayed secretory activation (where milk comes in after 72 hours).¹¹ These mothers are 60% more likely to stop breastfeeding at four weeks,¹² with many citing insufficient milk as the reason.¹³ Such challenges could be overcome if mothers were supported with initiation in the first few hours and days after birth.

Why Symphony® programs are so effective

The programs are based on Medela's extensive research into infant feeding behaviours. It is not just mothers' milk production that follows a continuum: infant feeding patterns do too.

In the early post-birth period, a newborn's time at the breast consists largely of 'non-nutritive', stimulating sucking. This is interspersed with short bursts of 'nutritive' sucking to gain small amounts of colostrum, plus pauses.¹⁴ The INITIATE program mimics these irregular sucking and pausing patterns.

As the mother's milk production increases during the Build stage, the infant starts feeding differently: beginning with rapid sucking to stimulate flow, then slowing down to take in more milk.¹⁵ This is why MAINTAIN has a 2-Phase Expression® model, starting with a higher-frequency stimulation phase,¹⁶ followed by a slower expression phase to obtain milk.¹⁷

More milk now and in the future

A randomised controlled trial¹ (RCT) of 105 mothers with preterm infants showed that using INITIATE, followed by MAINTAIN once secretory activation occurs, made 50% more milk available within the first 14 days (see diagram below), with the mothers' supply eventually 'catching up' with a term breastfeeding infant's milk intake.¹⁸

In addition, the MAINTAIN program initiates a faster milk ejection.^{16,19} Mothers do not always feel this, but can tell it is happening when milk starts to flow during pumping. Switching to the expression phase at this point helps obtain more milk, as the first ejection typically provides around 36% of a session's milk volume.²⁰

To benefit from these programs, a mother needs the right pump set. This is where Medela's latest innovation, the PersonalFit™ PLUS pump set for Symphony®, really makes a difference.

Symphony® helps make 50% more milk available over the first 14 days:¹⁸

7,580 ml
Healthy breastfeeding term infant

6,718 ml
With Medela's INITIATE program

4,379 ml
Using 2-Phase Expression® technology alone

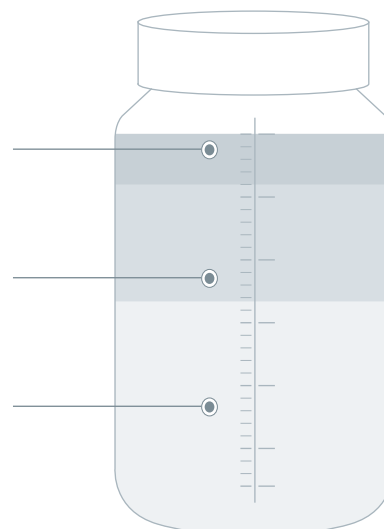

Benefits of PersonalFit™ PLUS for Symphony®4



After **15** mins
of pumping:



11%
more milk



4%
more breast drainage



PersonalFit™ PLUS: More milk and more comfort



The PersonalFit™ PLUS pump set's groundbreaking design is based on unique clinical studies conducted by Medela. These demonstrated – for the first time – the role breast shield design plays in optimising milk removal.^{4, 5, 21}

Using Symphony® with PersonalFit™ PLUS once milk has come in removes 11% more milk after 15 minutes, compared to standard pump sets. It also drains the breast 4% more effectively⁴ – good breast drainage is a key principle of maintaining milk production.⁷

Comfort is crucial for pump-dependent mothers, which is why Symphony® has an especially gentle²² gradual vacuum

increase feature. PersonalFit™ PLUS further enhances this with a unique breast shield that improves fit to the lactating breast to promote gentle expression.²¹

In addition, the PersonalFit™ PLUS pump set has overflow protection (also referred to as a closed system). The membrane within the connector helps stop milk overflowing into the tubing or motor during use. As a result, mothers do not have to sit upright when expressing, allowing them to find the most comfortable position for them. Being relaxed is important for successful pumping, as discomfort can hinder the production of oxytocin, essential for milk release.²³

All these benefits mean that Symphony® and PersonalFit™ PLUS work together to offer more milk for infants over the first days and weeks of life and beyond. And the more milk infants receive, the greater the support for their health.^{24–28}

Only Medela

Medela has continuously set industry standards since launching its first hospital-grade breast pump in 1980. The arrival of the research-based Symphony® in 2001, with its 2-Phase Expression® technology, heralded the start of a new era in breast milk expression. It raised the bar further in 2009, releasing the first version of its unique Initiation technology. Now PersonalFit™ PLUS is the latest innovation to set new standards in pumping performance.



View the evidence

1 Meier PP et al. J Perinatol. 2012; 32(2):103–110. **2** Post EDM et al. J Perinatol. 2016; 36(1):47–51. **3** Torowicz DL et al. Breastfeed Med. 2015; 10(1):31–37. **4** Prime DK et al. 6th ABM Europe Conference, Rotterdam, NL; 2018. **5** Clinical study. (NCT02496429). 2015. **6** Pang WW, Hartmann PE. J Mammary Gland Biol Neoplasia. 2007; 12(4):211–221. **7** Kent JC et al. J Obstet Gynecol Neonatal Nurs. 2012; 41(1):114–121. **8** Kent JC et al. Pediatrics. 2006; 117(3):e387–95. **9** Kent JC et al. Breastfeed Med. 2013; 8(4):401–407. **10** Parker LA et al. J Perinatol. 2012; 32(3):205–209. **11** Nommsen-Rivers LA et al. Am J Clin Nutr. 2010; 92(3):574–584. **12** Brownell E et al. J Pediatr. 2012; 161(4):608–614. **13** Gatti L. J Nurs Scholarsh. 2008; 40(4):355–363. **14** Sakalidis VS et al. J Hum Lact. 2013; 29(2):205–213. **15** Mizuno K, Ueda A. Pediatr Res. 2006; 59(5):728–731. **16** Kent JC et al. J Hum Lact. 2003; 19(2):179–186. **17** Mitoulas L et al. J Hum Lact. 2002; 18(4):353–360. **18** Neville MC et al. Am J Clin Nutr. 1988; 48(6):1375–1386. **19** Burton P et al. J Hum Lact. 2013; 29(3):412–419. **20** Prime DK et al. Breastfeed Med. 2011; 6(4):183. **21** Clinical study. (NCT02492139). 2016. **22** Meier PP et al. Breastfeed Med. 2008; 3(3):141–150. **23** Newton M, Newton N. J Pediatr. 1948; 33(6):698–704. **24** Schanler R et al. Pediatrics. 1999; 103(6 Pt 1):1150–1157. **25** Schanler RJ et al. Pediatrics. 2005; 116(2):400–406. **26** Vohr BR et al. Pediatrics. 2006; 118(1):e115–e123. **27** Patel AL et al. J Perinatol. 2013; 33(7):514–519. **28** Patel AL et al. NeoReviews. 2007; 8(11):e459–e466.

Discover what PersonalFit™ PLUS can do for your next generation. Go to medela.com/pfp or contact your Medela representative